

# HP® LASERJET PRO CM1415

## TONER CARTRIDGE REMANUFACTURING INSTRUCTIONS



HP® CM1415 TONER CARTRIDGE

# REMANUFACTURING THE HP LASERJET PRO CM1415 BLACK & COLOR TONER CARTRIDGES

By Mike Josiah and the Technical Staff at UniNet



First released in February 2011, the CM1415 series of color laser printers are based on a 12ppm black, 8ppm color, 600 dpi engine. These machines use an in-line, or single pass system. The CM1415 is a multifunction machine that can print, copy, scan and fax. The first page out black is under 26 seconds and color is under 32 seconds.

## MACHINES BASED ON THIS ENGINE

**LaserJet Pro CM1415fnw**  
**LaserJet Pro CM1415fn**  
**LaserJet Pro CP1525nw**

The CM1415 cartridge is an all-in-one type cartridge that consists of the toner supply, drum, and waste chamber. It's basically a rectangular shaped cartridge that comes with a toner seal and a snap-on drum cover across the bottom to protect the drum. New machines ship with starter cartridges rated for 750 pages, so users will run out of toner fairly quickly.

## CARTRIDGES USED IN THESE MACHINES

<b>CE320A (black)</b>	<b>2,000 pages</b>	<b>\$98.05 List*</b>
<b>CE321A (cyan)</b>	<b>1,300 pages</b>	<b>\$93.28 List*</b>
<b>CE323A (magenta)</b>	<b>1,300 pages</b>	<b>\$93.28 List*</b>
<b>CE322A (yellow)</b>	<b>1,300 pages</b>	<b>\$91.16 List*</b>

\*Pricing current, in U.S. American Dollars, as of June 2011.

With the new machines shipping with 750-page black and color starter cartridges, there is sure to be a fast growing demand for remanufactured cartridges!

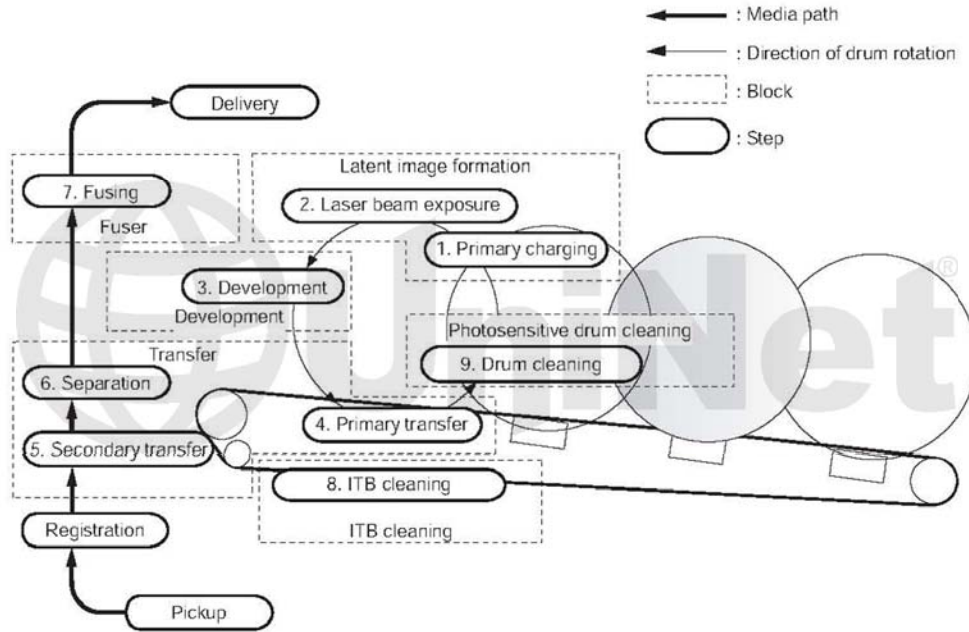

**HP CM1415 COLOR PRINTING THEORY**

The color toner cartridge printing process happens in a series of stages or steps. For the purpose of this article, we will call them stages. Shown here is the complete image formation process.

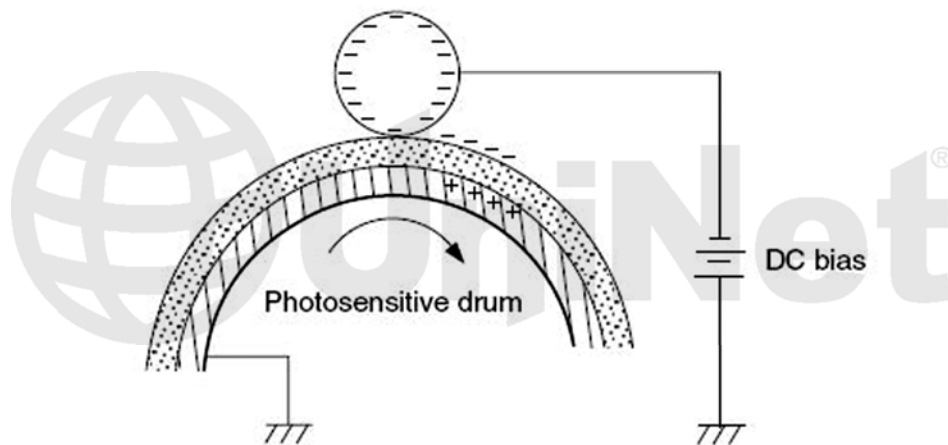

In the **first** stage, the Primary Charge Roller (PCR) places a uniform negative DC voltage on the OPC drum surface.

The amount of the negative DC voltage placed on the drum is controlled by the printer's intensity setting.

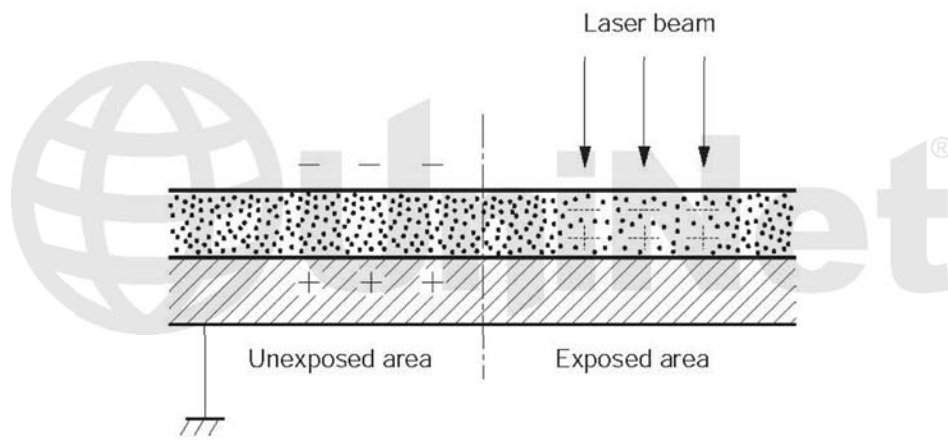
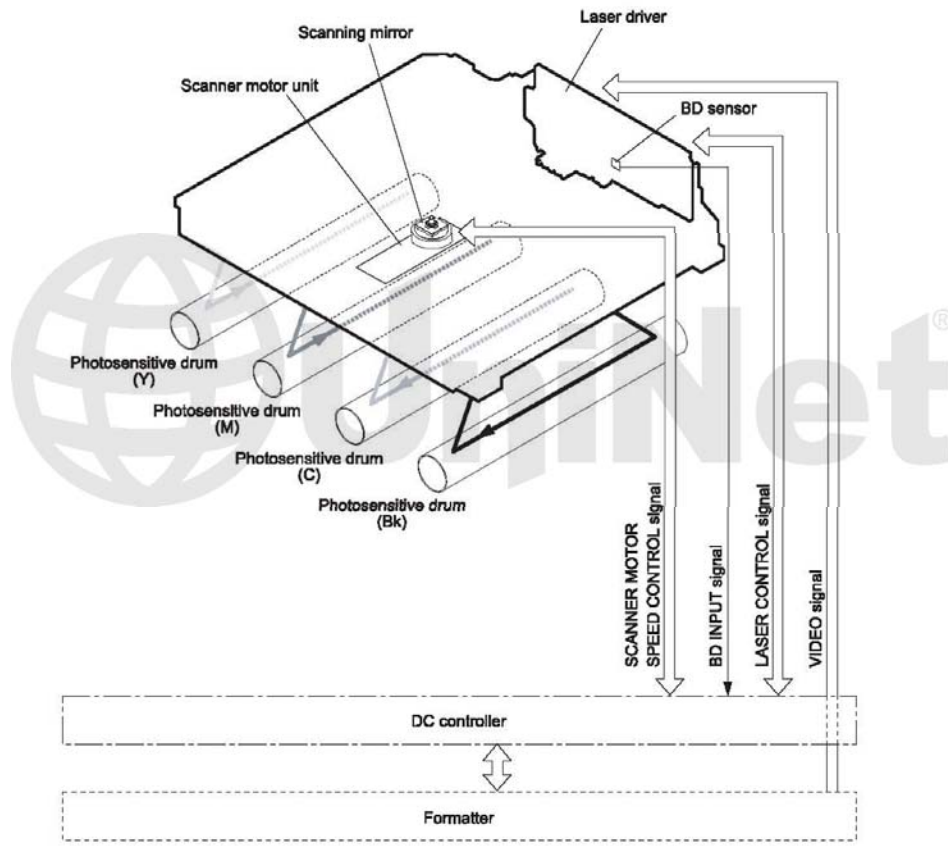

In the **second** stage, the laser beam is fired onto a rotating mirror (called the scanner). As the mirror rotates, the beam is reflected into a set of focusing lenses. The beam then strikes the drums surface, reducing the negative charge and leaving a latent electrostatic image on the drum. The areas where the laser did not strike the drum will retain the higher negative charge. Technology has advanced tremendously in these machines as there is one laser/scanner unit for all four colors. We imagine there are still four separate lasers, but we're not sure about the scanner motor(s). The only way to know for sure is to open one up, and we have not done that (yet).

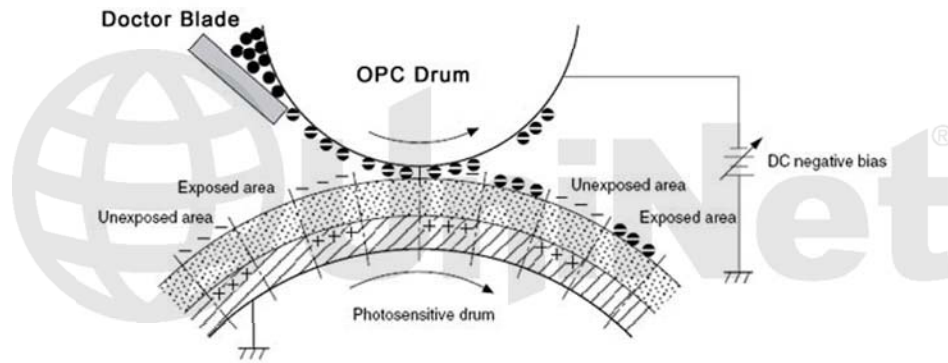

The **third** or developing stage is where the toner is developed on the drum by the developing section (or supply chamber), which contains the toner particles. The development stage is actually made up of two steps: toner charging, and the actual development. In the toner charging stage, the toner stirring blade turns inside the hopper. As it turns, friction causes a negative potential to develop on the toner. In addition, a foam feed roller brings the toner to the developer roller and also places a negative charge on the toner. These two charges help ensure a uniform charge on the toner. Once the toner is properly charged, the toner will coat the developer roller. The toner is also held onto and attracted to the developer roller by another negative DC bias voltage. This voltage is controlled by the printer's intensity setting and causes either more or less toner to be attracted by the developer roller. This in turn will either increase or decrease the print density. The amount of toner on the developer roller is controlled by the doctor blade, which uses pressure to keep the amount of toner on the roller constant. As the laser exposed areas of the OPC drum approach the developer roller, the toner particles are attracted to the drum's surface due to the opposite voltage potentials of the toner, and laser exposed areas of the OPC drum.

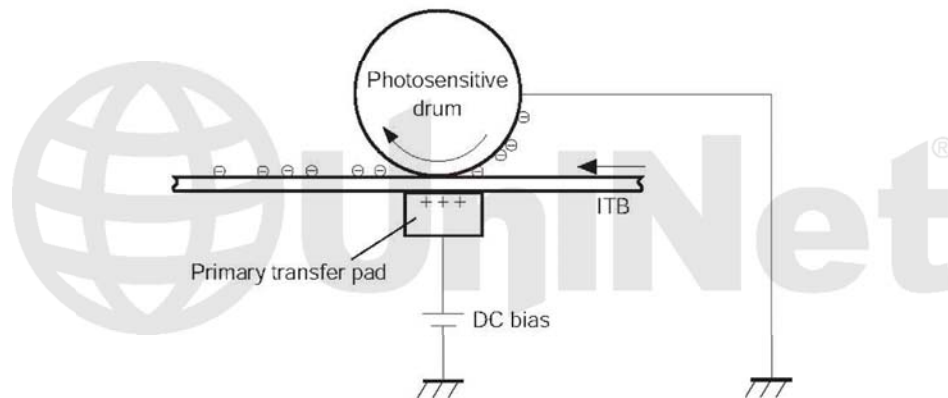

The **fourth** stage is the transfer stage. This is where there are some large differences from monochrome printers and also from other color lasers. In the primary transfer stage, the transfer pad (not a roller in this case) which is located directly opposite each OPC drum, places a positive DC bias charge on the back of the ITB or Image Transfer Belt. Each toner cartridge has a separate transfer charge pad. The image is transferred from the drum directly to the ITB. This process is repeated for each color cartridge in the following order: yellow, magenta, cyan, and black. At the same time, the paper is moving between the secondary transfer roller and the ITB. As the ITB passes the secondary transfer roller, the positive charge is picked up, and draws the negatively charged toner off the belt and onto the paper.

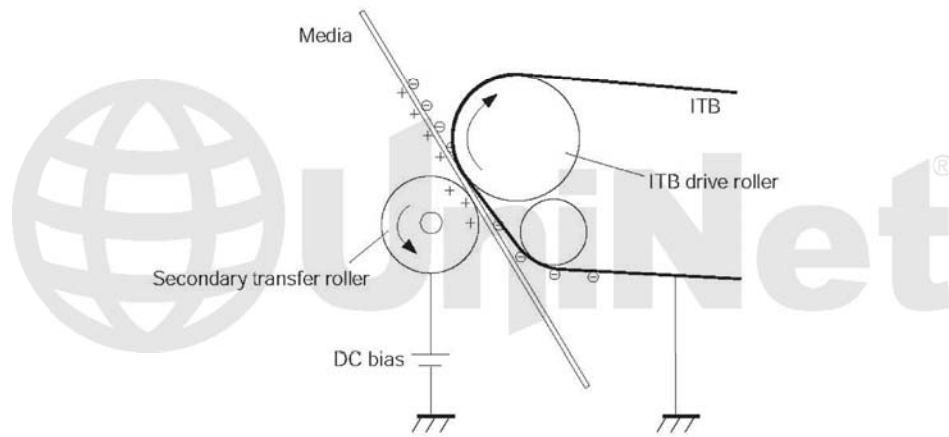

The paper separates from the ITB belt as the belt reaches the top of its path and turns back down to start the process again. The static charge on the back of the paper is decreased with static charge eliminator. This helps stabilize the paper feed, and also prevents toner flares (spots) under low temperature and low humidity conditions.

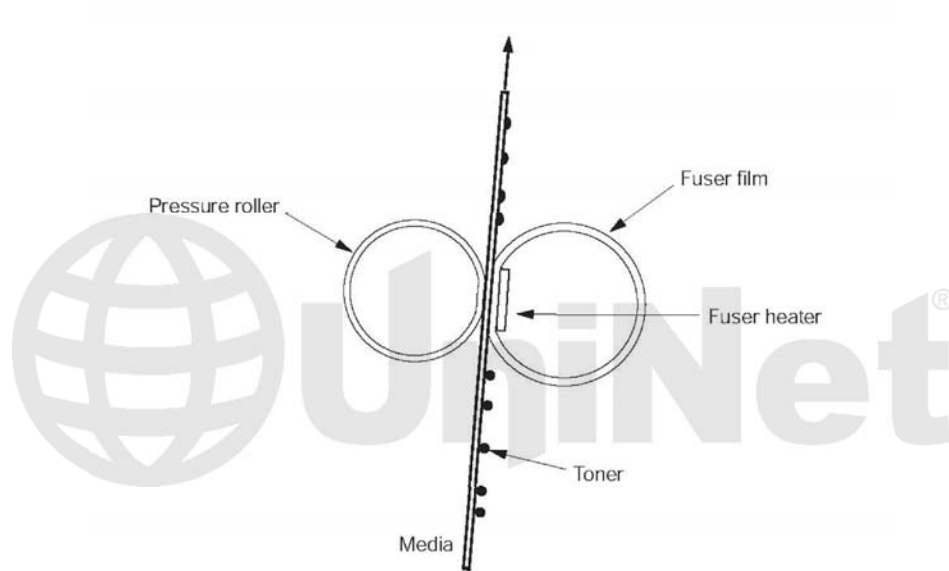

In the **fifth** stage, the image is then fused onto the paper by the fuser assembly. The fuser assembly is comprised of the upper heating assembly and lower pressure roller. The lower pressure roller presses the page up into the upper heating assembly which then melts the toner into the paper. This heating assembly consists of a flexible sleeve with a ceramic heating coil inside. This type of fuser affords “instant on” fusing with little to no wait time, and low power consumption.

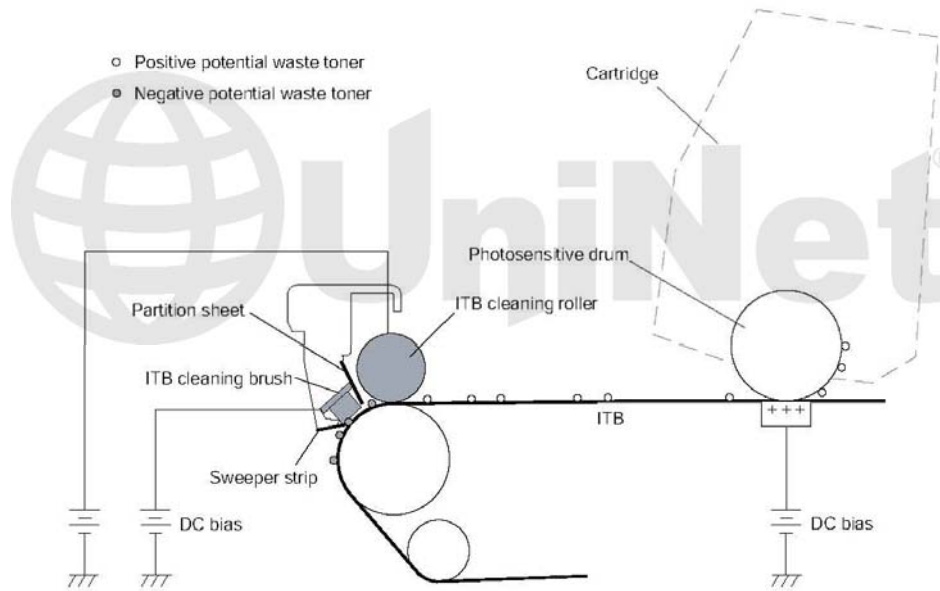

**ITB CLEANING**

The ITB is cleaned by both the ITB cleaning roller, and the ITB cleaning brush. Both the roller and brush have a DC positive bias placed on them which in turn places a positive DC Bias on the residual toner. The residual toner is then picked up by the OPC drum (because of the positive bias) and then cleaned off the drum by the wiper blade.

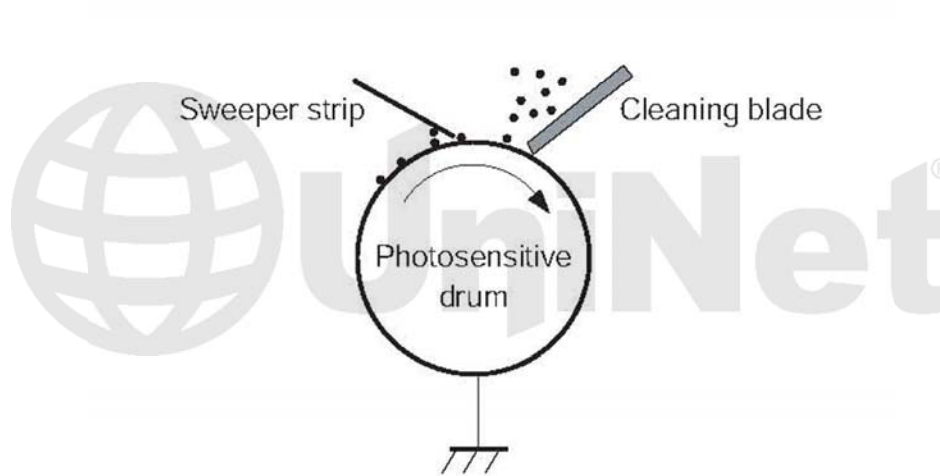

**OPC DRUM CLEANING**

The drum is cleaned after the image is transferred to the paper by the wiper blade. This part is fairly standard; the wiper blade scrapes the toner off the drum, and the recovery blade guides it into the waste chamber.

## PRINTER CALIBRATION

At the start of all this is the cartridge detection process, toner level detection, and then the calibration cycle. The printer will calibrate itself whenever the printer is turned on (within 15 minutes), when a new toner cartridge is installed and after 48 hours of run time. Calibration consists of a solid block and halftone of each color being printed to the ITB. As the printed areas get to the top of the belt, a sensor will detect them, measure the density, and adjust the printer accordingly. All of the calibration time settings are user controllable.

Taking test prints, cartridge troubleshooting as well as minor printer troubleshooting will be covered at the end of this article.

## REQUIRED TOOLS

1. Toner approved vacuum.
2. A small screw driver (common style)
3. A Phillips head screwdriver
4. Needle nose pliers

## SUPPLIES REQUIRED

1. Dedicated color toner for use in HP CM1415
2. New replacement chip
3. New drum for use in HP CM1415
4. New wiper blade
5. New toner feed roller (optional)
6. New PCR (optional)
7. New doctor blade (optional)
8. Drum cover
9. Lint free cloths
10. Conductive grease

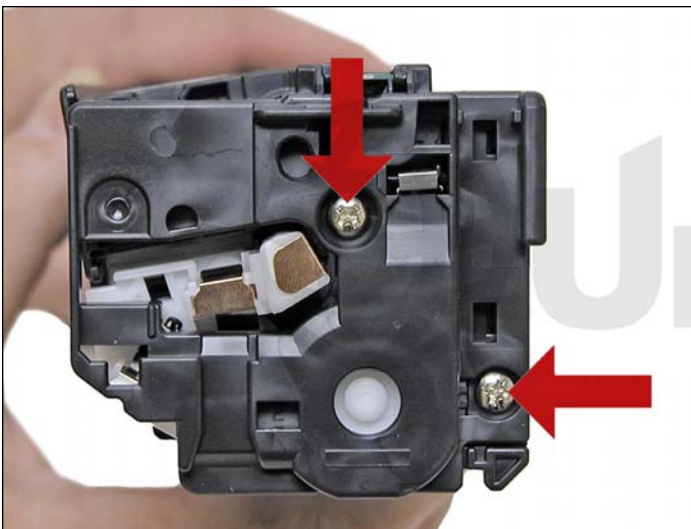

1. With the label on top and facing you, remove the two screws from the left side end cap.

Remove the end cap.



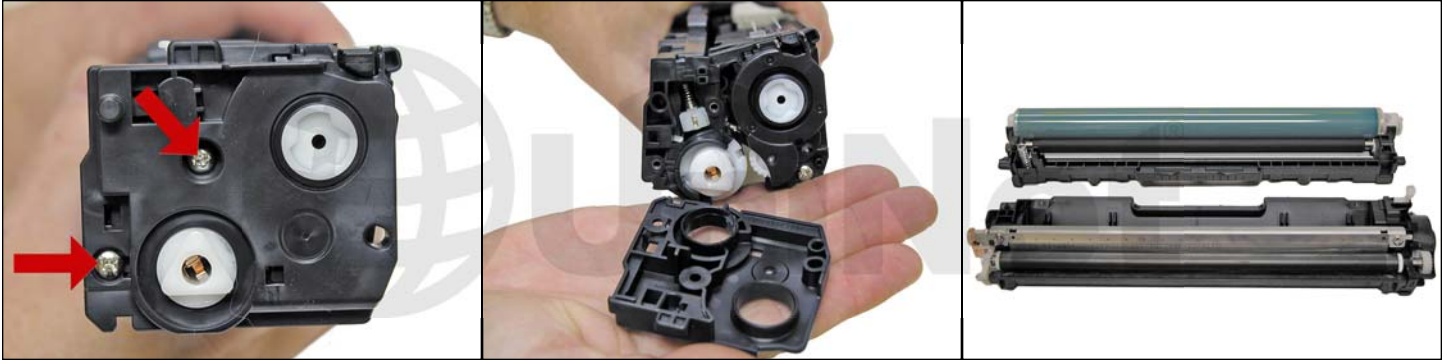

2. On the right side, remove the two screws and end cap.

Be careful: the two halves will start to separate and the drum will come loose!



3. Flip the waste chamber upside down, and remove the drum.



4. Remove the PCR.

Clean with your preferred PCR cleaner, and place aside.



5. Remove the two screws and wiper blade.

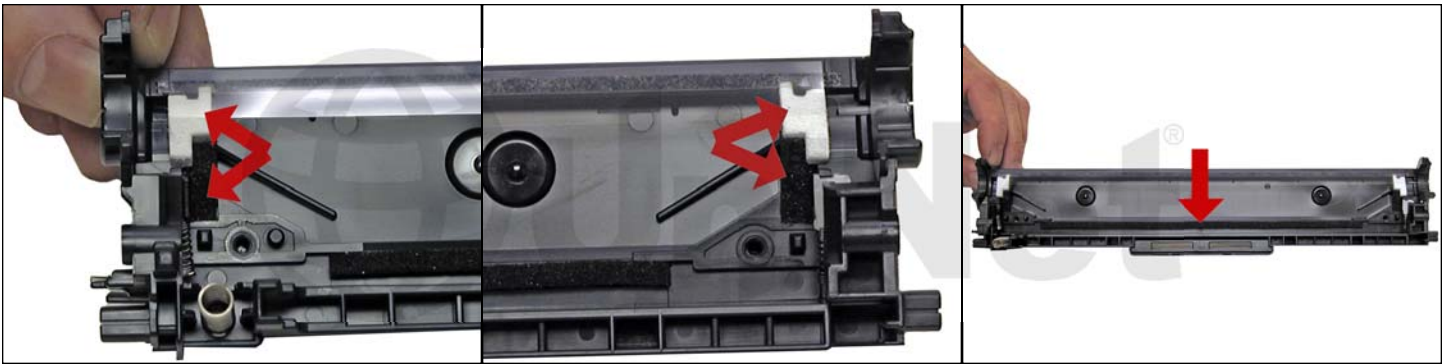

6. Clean out all the waste toner from the chamber.

Make sure all the wiper blade seals are clean.



7. Coat the new wiper blade with your preferred lubricant and install. Install the two screws.

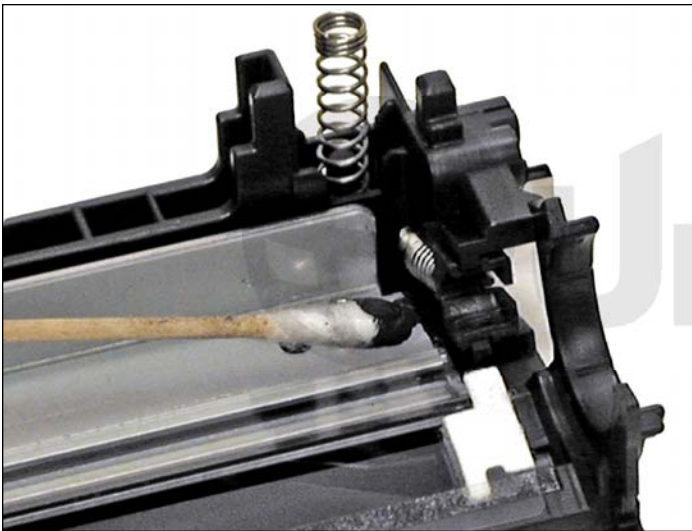

8. Install the cleaned PCR.

Make sure to place a small amount of conductive grease on the black PCR holder.

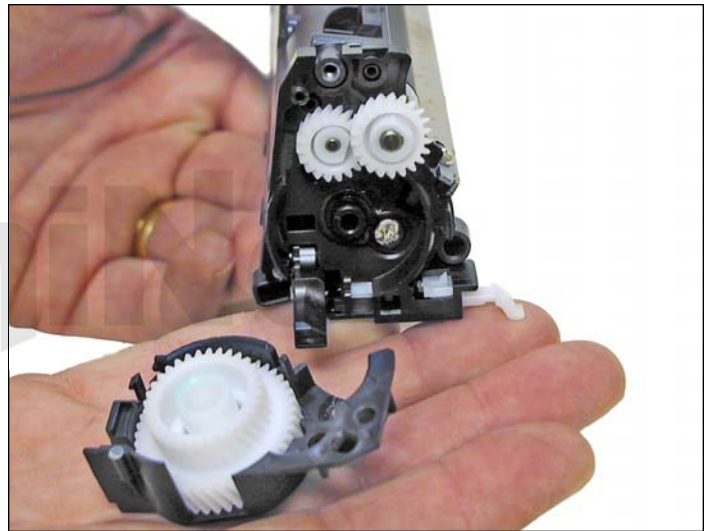
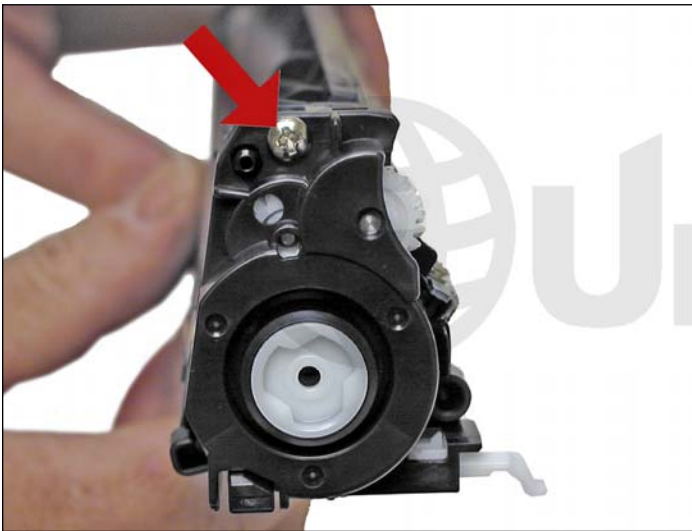

9. On the supply chamber, remove the screw from the gear/non-contact side end cap.

Carefully and gently work the end cap off the hopper.

There is a small plastic pin that will break off.

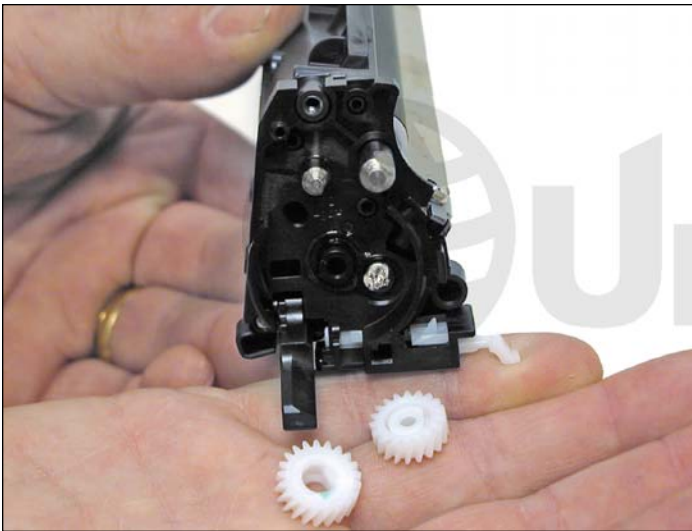

10. Remove the two gears.

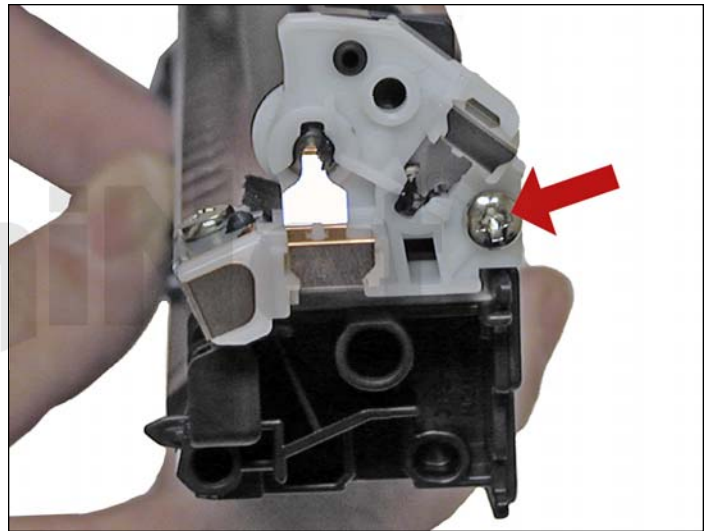

11. Remove the screw on the contact side end cap.



12. Slide the developer roller over and remove.



13. Remove the two screws and doctor blade.

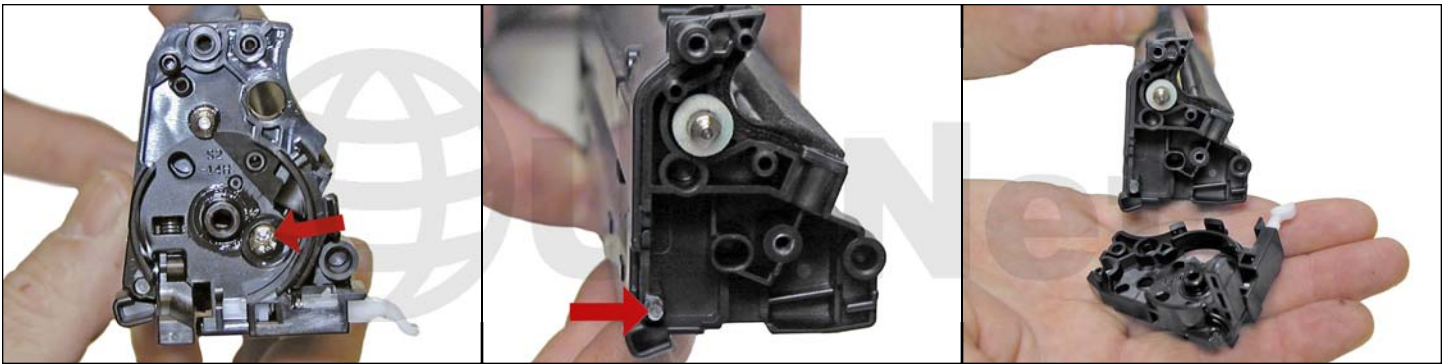

14. On the gear side of the hopper, remove the screw and inner end cap. Carefully work this end cap free. Use a small screwdriver if necessary to free the end cap from the plastic pin that broke earlier. Note the spring loaded arm assembly. We believe this arm is part of the cartridge detection system but nothing is mentioned about it in the service manual. The sensors for this are hidden by the transfer belt in the machine. We will figure out their purpose but for now, it's just a guess.



15. At this point, while tight, you can clean and fill the hopper with toner for use in HP CM1415.

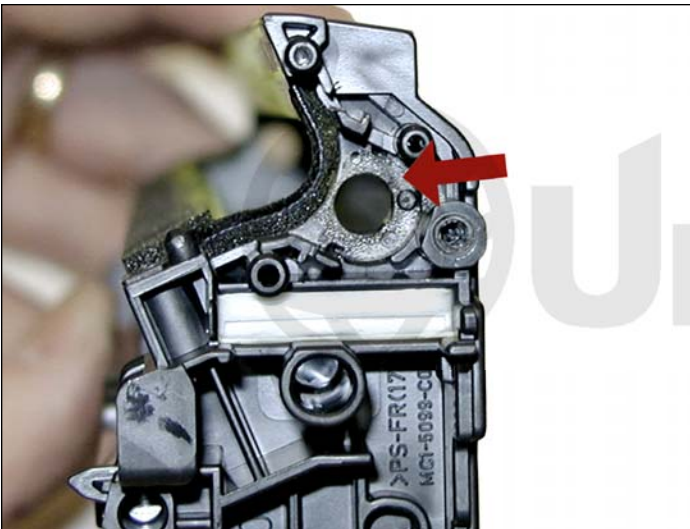

**NOTE:** HP/Canon created a bit of a block for us here. The clear bushing located on the right side of the hopper is glued in. The opposite side bushing is integral to the hopper. If you wish to install a seal, change the feed roller, or just have better access to the hopper, the feed roller must be pulled over to one side compressing the foam.



First remove the two white felt seals.



At this point we do not know if this will damage the roller or affect the printing at all.

So far in our tests it has not, but it's too early to say for sure.



16. If you have not already done so, fill the hopper with toner for use in HP CM1415 and install the feed roller.



17. Install the two white felt seals on the feed roller shaft.

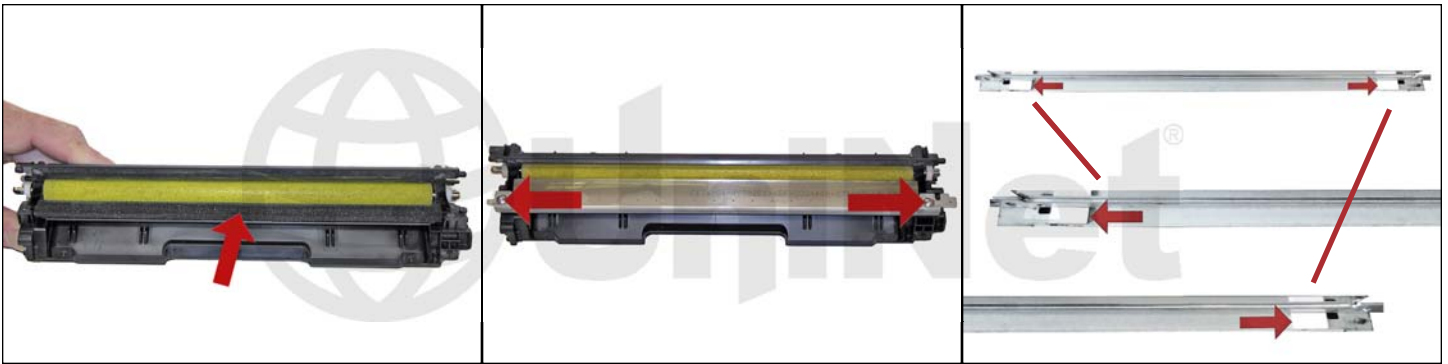

18. Clean the doctor blade foam seal.

Install the doctor blade and two screws.

Gap the doctor blade using a gapping tool or plastic shims as shown.





19. Install the developer roller.

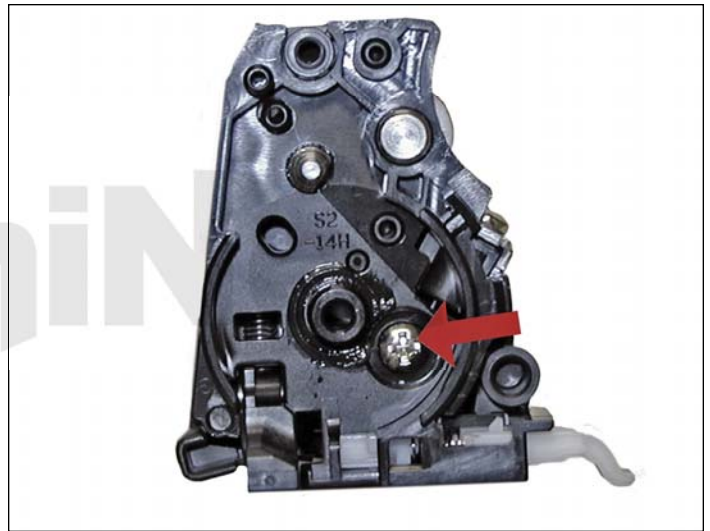

20. Install the inner end cap and screw. This end cap has a tight fit and snaps in place. Be careful here, the screw hole strips out easily.

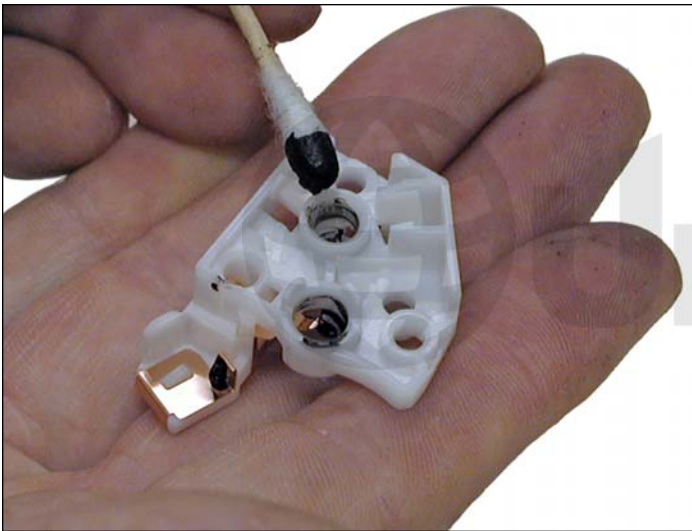

21. Clean the contact on the contact end cap with a cotton swab and alcohol. Replace the conductive grease with fresh grease. Remember, more is not better with this grease.

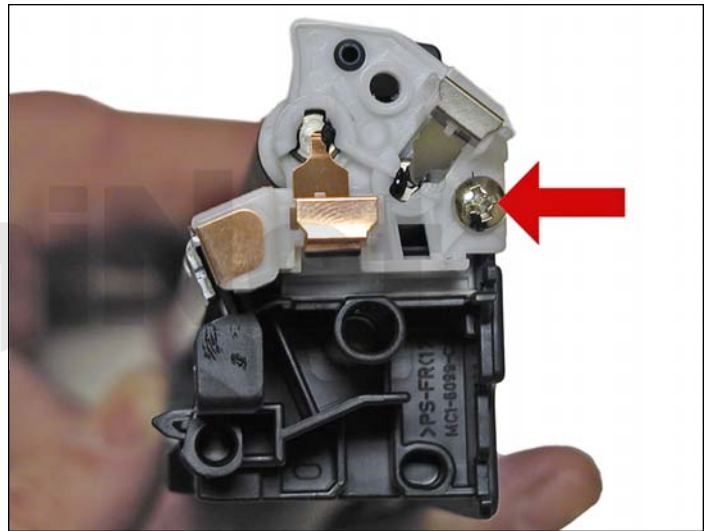

22. Replace the contact end cap and screw.



23. Replace the two gears on the feed and developer roller shafts.



24. Install the gear end cap and screw.

Make sure the spring arm works!



25. Coat the drum with you preferred lubricant and install the drum in the waste hopper.

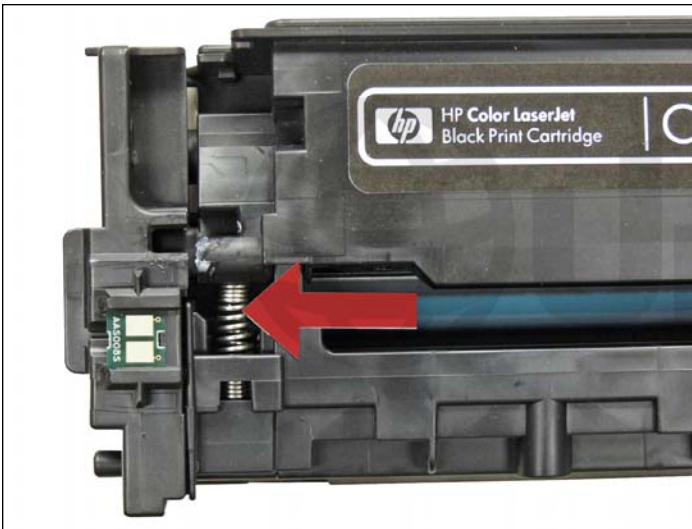

26. Hold the two halves together.

Align the spring on one side and the spring loaded arm on the other.



27. Install the outer gear side and cap and two screws.

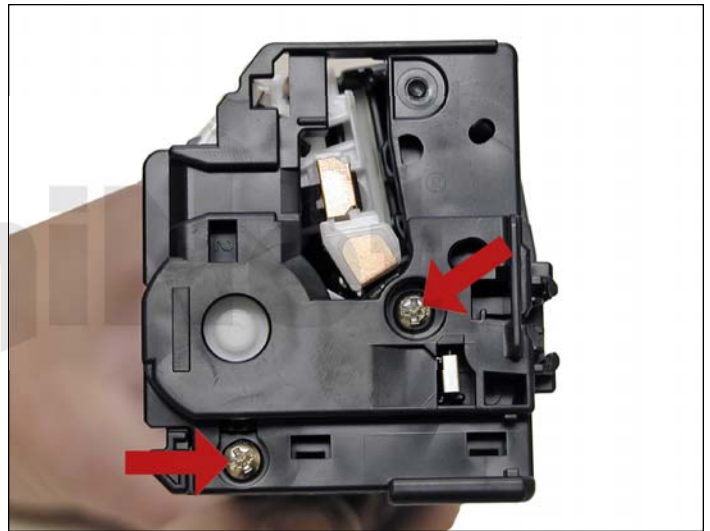

28. Install the remaining outer end cap on the contact side of the cartridge and two screws.

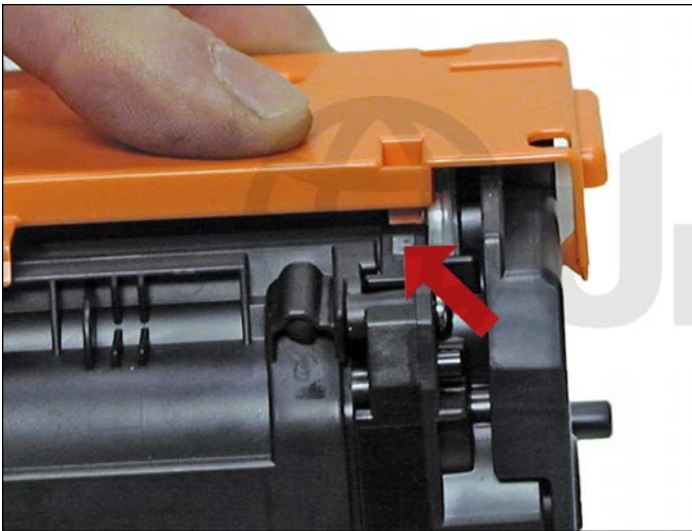

29. Install the drum cover on to the cartridge.

Spread the two halves apart slightly so it fits properly.





30. Remove the chip by cutting the plastic off the edges of both side of the chip.

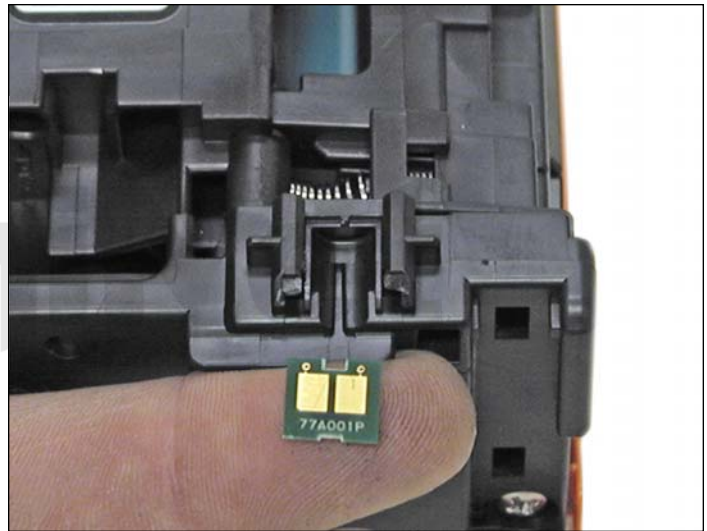

31. Remove and replace the chip.

If the new replacement chip is loose in the slot.

Close off the top edges with small amounts of hot glue.

### TAKING TEST PRINTS

#### Demo Page:

1. Press OK to open the menus.
2. Press the left or right arrow until "REPORTS" appears on the display. Press OK.
3. Press the left or right arrow until "DEMO PAGE" appears on the display. Press OK.

You also have the choice of running the Menu, Configuration, Supplies Status, Fonts, Usage, Diagnostics, and Print Quality pages from the reports Menu.

### REPETITIVE DEFECT CHART

<b>ITB:</b>	<b>633.6 mm (distance is longer than one full page)</b>
<b>OPC drum:</b>	<b>75.8 mm</b>
<b>Transfer rollers:</b>	<b>57.0 mm</b>
<b>Fuser pressure roller:</b>	<b>56.8 mm</b>
<b>Fuser sleeve:</b>	<b>56.5 mm</b>
<b>Registration roller:</b>	<b>44.0 mm</b>
<b>RS roller (feed roller):</b>	<b>28.5 mm</b>
<b>Primary charge roller:</b>	<b>26.7 mm</b>
<b>Developer roller sleeve:</b>	<b>22.3 mm</b>